

General Information on the **HMI** HOYME
**HAE - Hi-Efficiency Furnace Fan Generated
Counter-Flow Air to Air Heat Exchanger**

This air exchanger is designed to provide tempered fresh air into the home as stale air is ventilated outside. These Air Exchangers have a couple different configurations and are identified by specific numbers and letters.

There are two residential sizes and one commercial model.
Please refer to the Hoyme web at www.hoyme.com for more information.

The I.D. for this HAE - Air Exchanger is:

HAE-1000-100

(This is a residential inline Air Exchanger with ~120 CFM capacity)

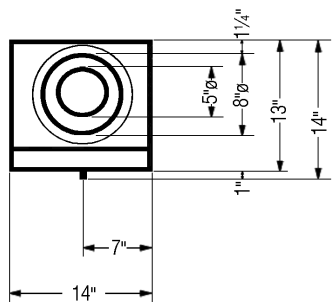

End View

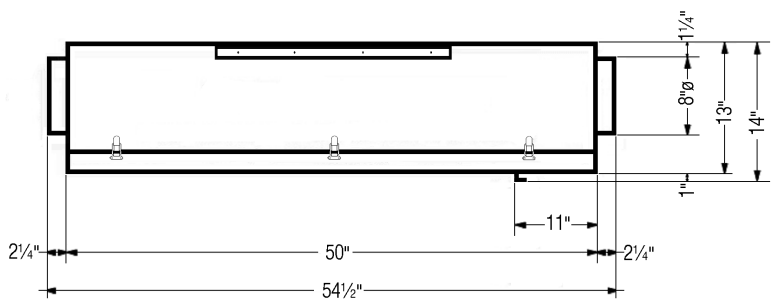

Side View

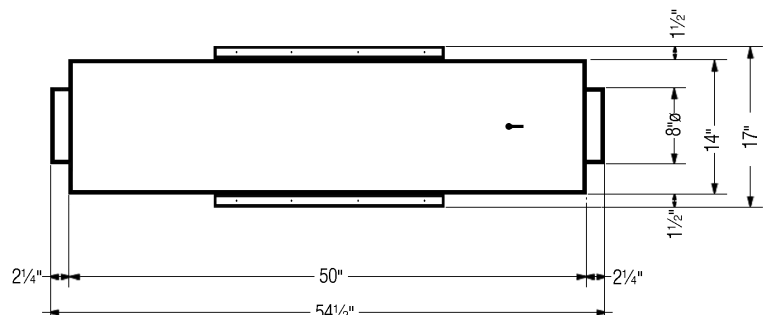
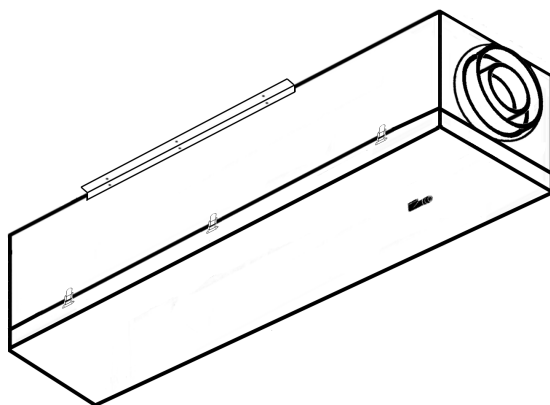

Bottom View